



INFINITYLINK ILC156M/D



**10G 3G/HD/SD-SDI, ASI 6 Channel Mux/Demux
Installation and Operations Manual**



ILC156 Function Modules

10G 3G/HD/SD-SDI, ASI 6 Channel Mux/Demux

Installation and Operations Manual

Document Number: AR200-006201-00_B
Released: December, 2017



COPYRIGHT

This manual is produced and copyrighted by Artel Video Systems Corporation. Any use or reproduction of the contents of this manual without the prior written consent of Artel Video Systems Corporation is strictly prohibited.

NOTICE

All title and copyrights to this document are owned by Artel Video Systems Corporation. No part of the contents of this document may be reproduced or transmitted in any form or by any means without the written permission of Artel Video Systems Corporation.

Artel Video Systems Corporation shall not be liable for errors contained herein. Artel Video Systems Corporation shall not be liable for any damages whatsoever, including, without limitation, damages for loss of business profits, business interruption, loss of business information, or other pecuniary loss arising out of the use of this documentation even if Artel Video Systems Corporation has been made aware of the possibility of such damages.

Information contained in this document is subject to change without notice. While every effort is made to ensure that the information is accurate as of the publication date, users are reminded to update their use of this document with documents published by Artel Video Systems Corporation subsequent to this date. Updates may be available at www.artel.com or by contacting Artel Video Systems Corporation.

Third-party product information is for informational purposes only, and constitutes neither an endorsement nor a recommendation. Artel Video Systems Corporation assumes no responsibility with regard to the performance of the third-party products.

Copyright © 2017 by Artel Video Systems Corporation
ALL RIGHTS RESERVED
Printed in U.S.A.

Artel Video Systems Corporation
5B Lyberty Way
Westford, MA 01886
(978) 263-5775

www.artel.com

Revision history for the *ILC156 Function Modules Installation and Operations Manual*.

Table 0-1. Manual Revision History

Revision History			
Revision	Document Number	Date	Reason for Change
A	AR200-006201-00_A	December, 2016	Initial release.
B	AR200-006201-00_B	December, 2017	Modified "Cabling the ILC156D Module" section and Table 9. ILC156D Front and Rear Panel Status LEDs



Table of Contents

About This Manual

Audience.....	ix
Related Documentation	ix
Symbols and Conventions.....	x
Artel Customer Service	x

ILC156 Function Modules

Information About the ILC156.....	1
Understanding and Using the ILC156M.....	2
ILC156M Module Functional Description.....	2
Overview of the ILC156M Module.....	3
Configuring the ILC156M Module.....	5
Configuring the Video Rate with SW1, SW2, and SW3.....	5
Enabling Channels with DIP Switch SW4	6
Configuring Repeater and EMS Features with DIP Switch SW5.....	7
Installing the ILC156 Module and XFP	8
Cabling the ILC156M Module	10
Monitoring the ILC156M Module Operation.....	10
Understanding the ILC156M Status LEDs	10
Using the ILC156M Monitor Jack	12
Removing the XFP and ILC156 Module	12
Removing the XFP	12
Removing the ILC156 Module	13
Understanding and Using the ILC156D	13
ILC156D Module Functional Description	13
Overview of the ILC156D Module	15
Configuring the ILC156D.....	16
Enabling Channels with Switch SW1	17
Enabling Video Alarm, Optical Repeater, and EMS with DIP Switch SW2.....	17
Installing the ILC156D Module and XFP.....	18
Cabling the ILC156D Module.....	18
Monitoring the ILC156D Module Operation	19
Understanding the ILC156D Status LEDs.....	19
Using the ILC156D Monitor Jack	21
Removing the XFP and ILC156D Module.....	21

Index



About This Manual

This manual provides instructions for installing, configuring, and operating the ILC156 function modules, which consist of the ILC156M (mux) and ILC156D (demux) modules.

Audience

This manual is intended for the following trained and qualified service personnel who are responsible for installing and operating the ILC156:

- System installer
- Hardware technician
- System operator

Related Documentation

The following documentation contains material related to the ILC156 function module:

Document	Provides ...
<i>ILC156M/ILC156D Data Sheet</i>	Product operating and environmental specifications, and regulatory conformance information.
<i>ILC156M Quick Start Guide and ILC156D Quick Start Guide</i>	Product configuration information using the IL Manager element management system and descriptions of the front panel status LED operations.
<i>InfinityLink IL6000 Chassis Installation and Operations Manual</i>	Overview and installation instructions for the InfinityLink media transport platform chassis options, including the following: <ul style="list-style-type: none">• IL6000 chassis—Installation of this 4-slot chassis, power supplies, and function modules.
<i>InfinityLink IL6000 Data Sheet</i>	Overview of the InfinityLink video platform chassis options.
<i>InfinityLink Manager Setup and Operations Manual</i>	Overview and operating instructions for the InfinityLink Manager element management system.

Symbols and Conventions

This manual uses the following symbols and conventions.

Caution

A caution means that a specific action you take or fail to take could cause harm to the equipment or to the data transmission.



Warning

A warning describes an action you take or fail to take that could result in death, serious physical injury, or destruction of property.

Note: Important related information, reminders, and recommendations.

Italics—used for emphasis, for indicating the first occurrence of a new term, and for book titles

1. Numbered list—where the order of the items is important
 - Bulleted list—where the items are of equal importance and their order is unimportant

Artel Customer Service

You can reach Customer Service by e-mail at customer@artel.com or by telephone:

In the US call (800) 225-0228, then select 1 for technical support.

Outside the US call (978) 263-5775, then select 1 for technical support.

When requesting assistance, please be ready to provide the following information:

- Your name and telephone number
- Product model and serial number
- Brief description of the problem
- List of symptoms
- Steps you have already taken to try to resolve the problem

If the product is damaged

If any portion of the unit is damaged, forward an immediate request to the delivering carrier to perform an inspection of the product and to prepare a damage report. Save the container and all packing materials until the contents are verified.

Concurrently, report the nature and extent of the damage to Artel Customer Service so that action can be initiated to either repair or replace the damaged items.

Do not return any items to Artel until you obtain instructions from Customer Service.

Report the problem or deficiency to Customer Service along with the model number and serial number. Upon receipt of this information, Artel will provide service instructions, or a *Return Authorization Number* and shipping information.

ILC156 Function Modules

10G 3G/HD/SD-SDI, ASI 6 Channel Mux/Demux

Information About the ILC156

This manual introduces the two ILC156 function modules and includes information for installing and configuring the modules. The ILC156 can transport up to six DVB-ASI, SD, HD-SDI or three 3G-SDI digital video services over a single optical wavelength. Powerful Forward Error Correction (FEC) is used on the optical transmission to insure bit error-free video. Using time division multiplexing (TDM), each channel is assigned a fixed time-slot, eliminating complex configurations.

The six-channel ILC156 is available in the following models:

- ILC156M—Multiplexer that can aggregate six independent, mixed format video signals onto a single wavelength. Two time slots can be combined to carry 3G-SDI. The electrical inputs are received using the module's six BNC connectors. Optionally, up to five of the inputs can be received from other modules using backplane connections.
- ILC156D—De-multiplexer that can receive the aggregated optical signals, separate them, and output them to six BNC connectors. Optionally, up to five of the channels can be output to other modules using backplane connections.

The ILC156D can be configured to operate as a repeater to extend the range of a link while de-multiplexing signals for local use.

The ILC156 uses a 10.7 Gb/s XFP transceiver for WDM (1310 nm, 1550 nm), CWDM ITU G.694.2, and DWDM ITU G.694.1.

You provision and monitor the ILC156 using DIP switches, LEDs, front panel monitor jack, or Artel's InfinityLink Manager (IL Manager), which is an element management system (for more information, see the *InfinityLink Manager Setup and Operations Manual*).

This chapter contains the following additional major sections:

- [“Understanding and Using the ILC156M” section on page 2](#)
- [“Understanding and Using the ILC156D” section on page 13](#)

Understanding and Using the ILC156M

This section, which describes how the ILC156M works and how to configure, install, and cable the module, contains the following topics:

- [ILC156M Module Functional Description \(page 2\)](#)
- [Overview of the ILC156M Module \(page 3\)](#)
- [Configuring the ILC156M Module \(page 5\)](#)
- [Installing the ILC156 Module and XFP \(page 8\)](#)
- [Cabling the ILC156M Module \(page 10\)](#)
- [Monitoring the ILC156M Module Operation \(page 10\)](#)
- [Removing the XFP and ILC156 Module \(page 12\)](#)

ILC156M Module Functional Description

This section provides a functional description of the ILC156M, including [Figure 1](#), which is a functional block diagram of the module.

Figure 1. ILC156M Module Functional Block Diagram

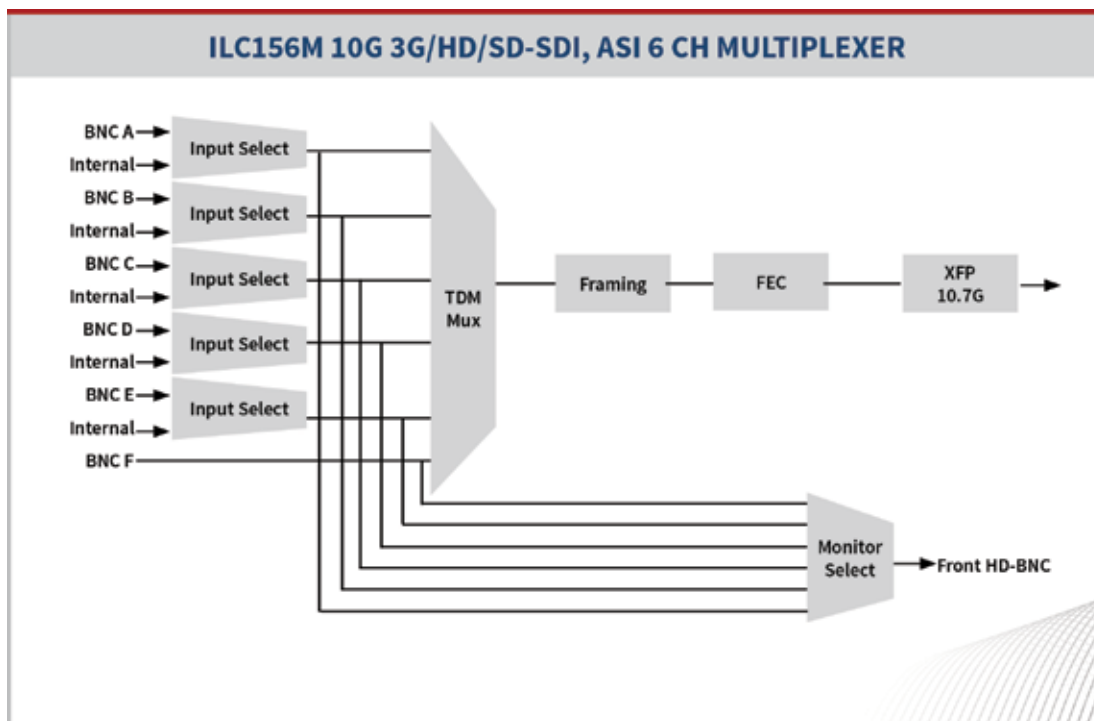

Electrical Inputs and Outputs

The ILC156M uses the following electrical inputs and outputs:

- Six rear panel BNC connectors for channels A to F inputs.

- Backplane connectors for receiving inputs from other host chassis modules.
- Front-panel monitor jack, which is a 75 Ohm HD-BNC connector that allows you to monitor the input video signals on each channel.

Optical Inputs and Outputs

A single XFP socket provides the optical interface for outputting the aggregated optical signal. The XFP modules use LC connectors. Optical performance is dependant on the quality of your optical fiber and fiber interconnects, and on the selected XFP module, which must be specifically qualified by Artel. Consult Artel for available XFP options.

Overview of the ILC156M Module

This section provides an overview of the components that make up the ILC156M.

Figure 2. ILC156M Module Major Components

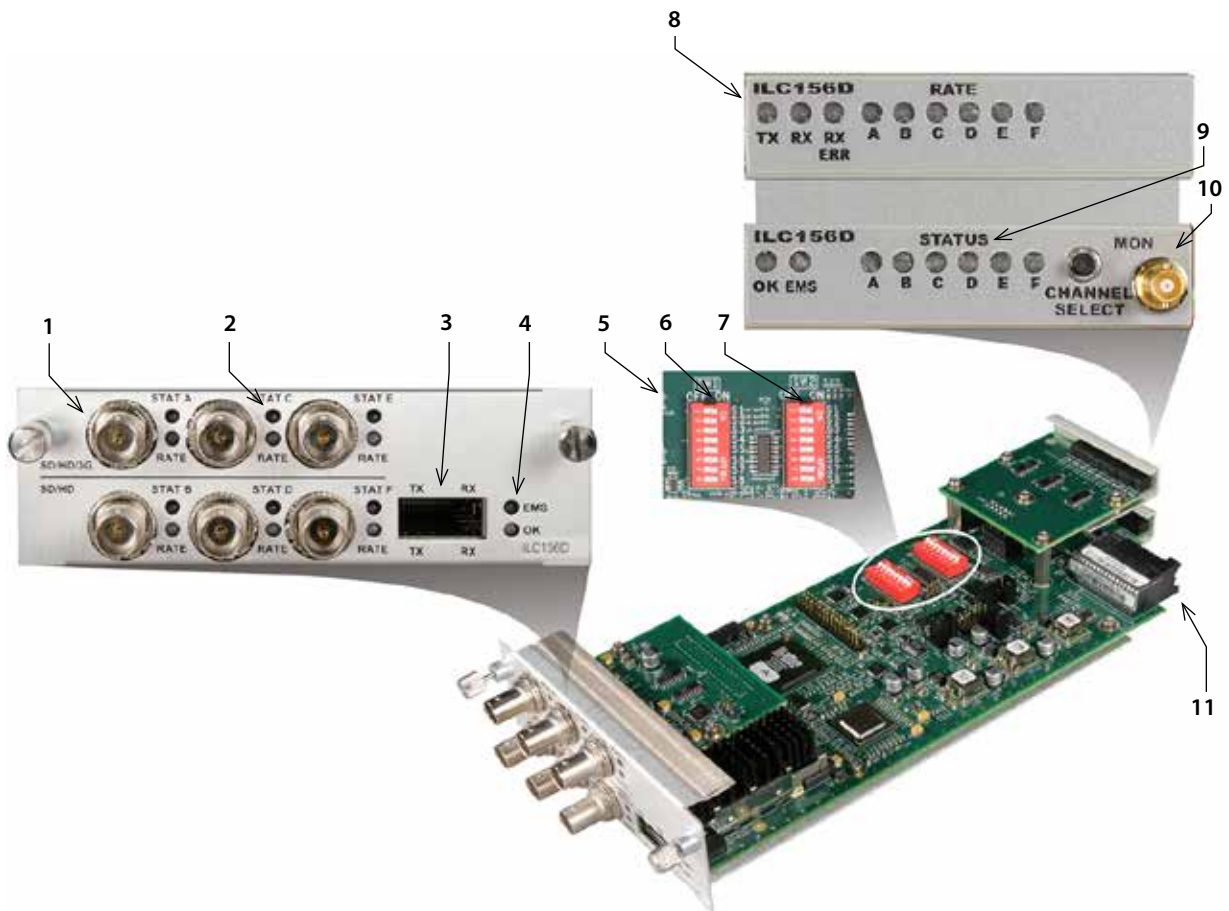

Table 1. ILC156M Elements

Item	ILC156M Element	for details, see...
1	BNC channel connectors for receiving SD and HD video when used individually or SD, HD, and 3G when used as channel pairs as follows: <ul style="list-style-type: none"> • A—Paired with Channel B for 3G operation • B • C—Paired with Channel D for 3G operation • D • E—Paired with Channel F for 3G operation • F 	Cabling the Video Input BNC Connections (page 10)
2	Rear panel BNC channel input status LEDs: <ul style="list-style-type: none"> • STAT—Input status indicator • RATE—Input rate indicator 	Understanding the ILC156M Status LEDs (page 10)
3	XFP socket for the following optical connections: <ul style="list-style-type: none"> • TX—Transmits the aggregated video signal • RX—Receive (not used) 	Cabling the XFP Connections (page 10)
4	Rear panel module status LEDs: <ul style="list-style-type: none"> • EMS—Element management system indicator • OK—Alarm indicator 	Understanding the ILC156M Status LEDs (page 10)
5	Rate selector switches SW1, SW2, and SW3.	Configuring the ILC156M Module (page 5)
6	Channel enable DIP switch SW4.	
7	Video alarm enable and EMS enable DIP switch SW5.	
8	Front panel status LEDs: <ul style="list-style-type: none"> • TX—XFP transmit status indicator • RATE A–F—BNC receive rate indicator • OK—Alarm indicator • EMS—Element management system indicator • STATUS A–F—Channel status indicator 	Understanding the ILC156M Status LEDs (page 10)
9	Front panel Channel Select switch—Allows you to select the channel signal to monitor.	Using the ILC156M Monitor Jack (page 12)
10	Front panel monitor 75 Ohm HD-BNC output jack.	
11	Backplane connector—Provides power to the module, allows the module to share signals with other function modules, and is used for alarm and management signals.	N/A

Configuring the ILC156M Module

This section describes how to configure the operation of the ILC156M. You must configure the module while it is out of the chassis because the configuration switches are mounted to the top of the module printed circuit board.

Artel ships the ILC156M configured to operate as follows:

- All six channels enabled
- No video detected alarm disabled
- EMS override enabled (IL Manager can change the ILC156M configuration)
- 3G disabled on all inputs

This section contains the following topics:

- [Configuring the Video Rate with SW1, SW2, and SW3 \(page 5\)](#)
- [Enabling Channels with DIP Switch SW4 \(page 6\)](#)
- [Configuring Repeater and EMS Features with DIP Switch SW5 \(page 7\)](#)

Configuring the Video Rate with SW1, SW2, and SW3

Switches SW1, SW2, and SW3 enable or disable 3G video rate operation for each channel. Each switch controls the operation of a channel pair. For example, SW1 controls the operation of Channels A and B as follows:

- **ON**—3G video rate operation is disabled and Channels A and B can independently transmit SD or HD video.
- **OFF**—3G video rate operation is enabled and Channel A only can transmit SD, HD, or 3G video. Channel B is disabled.

Figure 3. ILC156M Switches SW1, SW2, and SW3

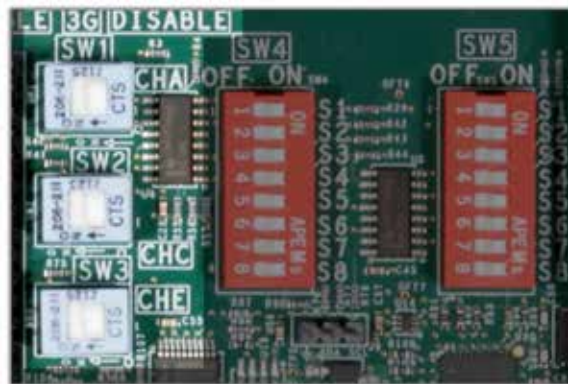

Table 2 describes the switch SW1, SW2, and SW3 configuration options. The factory-set configuration settings are shown in bold type.

Table 2. ILC156M Switch SW1, SW2, and SW3 Settings

Switch	ON	OFF
SW1	Channels A and B support SD or HD.	Channel A supports SD, HD, or 3G. Channel B is disabled.
SW2	Channels C and D support SD or HD.	Channel C supports SD, HD, or 3G. Channel D is disabled.
SW3	Channels E and F support SD or HD.	Channel E supports SD, HD, or 3G. Channel F is disabled.

Enabling Channels with DIP Switch SW4

DIP Switch SW4 determines which video channels are enabled or disabled.

Figure 4. ILC156M DIP Switch SW4



Table 3 describes the DIP switch SW4 configuration options. The factory-set configuration settings are shown in bold type.

Note: All reserved switches must be left in the **ON** position.

S1	A	Enabled	Disabled	S5	E	Enabled	Disabled
S2	B	Enabled	Disabled	S6	F	Enabled	Disabled
S3	C	Enabled	Disabled	S7	Reserved (leave ON)	X	–
S4	D	Enabled	Disabled	S8	Reserved (leave ON)	X	–

Configuring Repeater and EMS Features with DIP Switch SW5

DIP Switch SW5 enables or disables the video alarm and EMS functions.

Figure 5. ILC156M DIP Switch SW5

Table 4 describes the DIP switch SW5 configuration options. The factory-set configuration settings are shown in bold type.

Note: All reserved switches must be left in the **ON** position.

Table 3. DIP Switch SW5 Settings

Switch	Function	ON	OFF
S1	Reserved (leave ON)	X	–
S2	Reserved (leave ON)	X	–
S3	Video alarm	No alarm.	Loss of video on an enabled input causes a major alarm.
S4	Reserved (leave ON)	X	–
S5	Reserved (leave ON)	X	–
S6	Reserved (leave ON)	X	–
S7	Reserved (leave ON)	X	–
S8	EMS Enable	IL Manager can override the local switches.	IL Manager cannot override the local switches.

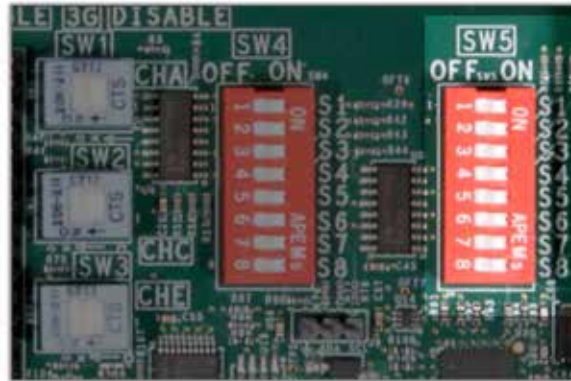
Installing the ILC156 Module and XFP

The ILC156 and associated XFP are hot swappable, enabling you to safely install them while power is applied to the host chassis. Before you install the ILC156, see the ILC156 data sheet for a detailed description of the module specifications including environmental requirements that you must adhere to when installing the module.

Note: This procedure applies to the ILC156M and ILC156D modules, which are double-high function modules that require two host chassis slots each.

To install the ILC156 in the host chassis (see [Figure 6](#)), perform the following steps:

1. From the back of the chassis, determine the two slots that the module is to occupy.
2. Remove the two screws that secure the blank trays to two of the unused function module slots (if necessary). Use any available function module slots.
3. Slide the ILC156 into the double-high chassis slot using the printed circuit board guide rails on either side of the slot.
4. Push the ILC156 in until it is firmly seated into the backplane and flush with the chassis.
5. Tighten the two mounting screws that secure the module to the chassis.

Note: Failure to properly secure the ILC156 to the chassis with the two mounting screws can result in disconnecting the module from the backplane when you attach a cable to the monitor connector located on the front panel.

6. Install the Artel-approved XFP in the ILC156 with the handle on top as shown in [Figure 6](#). Push the XFP into the socket located on the right side of the function module until it is firmly seated into the socket.

Note: When you do not install an XFP, the TX LED located on the ILC156 front panel will flash. See [Table 5](#) (ILC156M) or [Table 9](#) (ILC156D) for other LED status indications.

7. Insert a blank tray in any unused chassis module slots to maintain proper ventilation.

Figure 6. ILC156 Module and XFP Installation

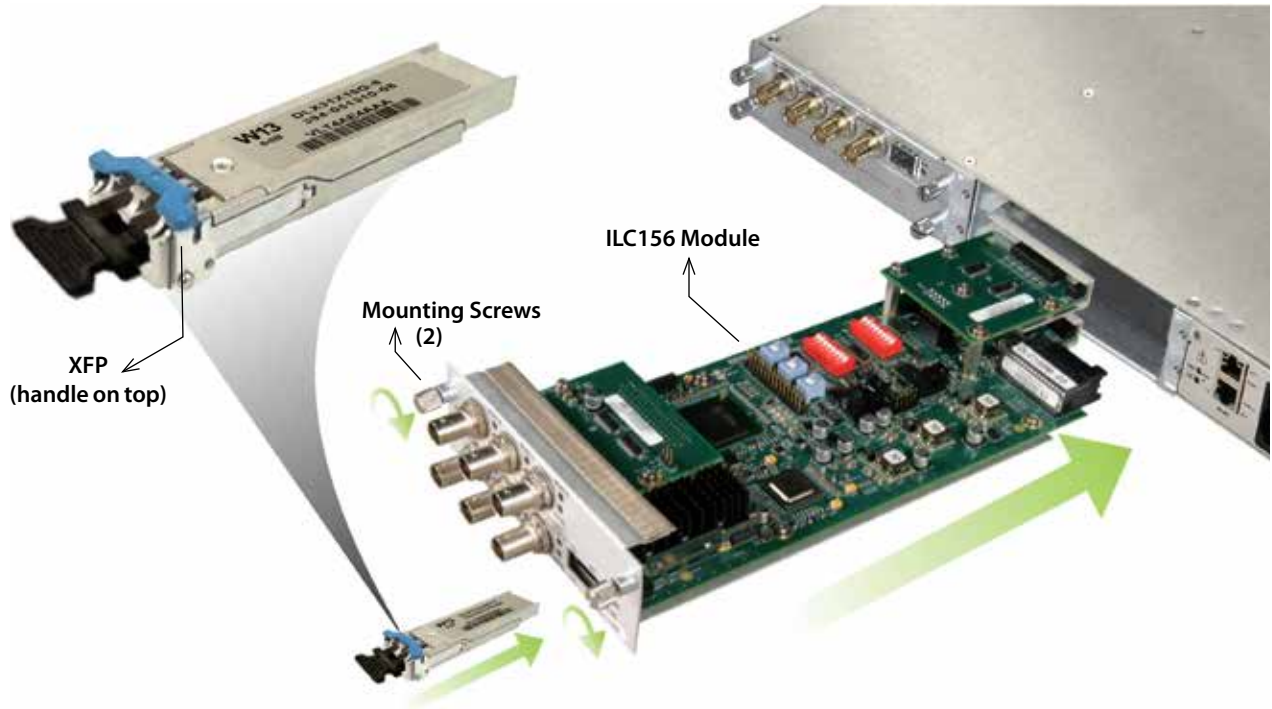

Depending on the ILC156 model, proceed to one of the following sections:

- [Cabling the ILC156M Module \(page 10\)](#)
- [Cabling the ILC156D Module \(page 18\)](#)

Cabling the ILC156M Module

The ILC156M can receive video network signals over BNC electrical cable connections (see [Figure 7](#)) and optionally from the backplane connector for channels E and F. The ILC156M transmits signals through an optical XFP. The cabling configuration that you use depends on your application.

Figure 7. ILC156M BNC Connectors and XFP Socket



Cabling the Video Input BNC Connections

Use a high quality 75 Ohm precision video coax cable, such as Belden 1694A cable, when cabling to the ILC156M BNC connectors to the video source devices.

Cabling the XFP Connections

Use a single mode fiber when connecting to the LC connectors of the ILC156M XFP.

To cable the optical connections, perform the following tasks:

1. Remove the XFP safety plug that protects the TX port. Cover the unused RX optical port to keep the port clean.
2. Connect the fiber optic cable between the XFP transmit optical connector (TX) on the ILC156M and the destination video device.

Monitoring the ILC156M Module Operation

This section describes how to monitor the ILC156M operations using the front and rear panel LEDs and the front panel monitor connector.

This section contains the following topics:

- [Understanding the ILC156M Status LEDs \(page 10\)](#)
- [Using the ILC156M Monitor Jack \(page 12\)](#)

Understanding the ILC156M Status LEDs

[Table 5](#) describes the different states of the ILC156M status LEDs as shown in [Figure 8](#).

Figure 8. ILC156M Status LEDs and Monitor Connector

Table 4. ILC156M Front and Rear Panel Status LEDs

LED	Indicates ...	State	Description
OK	ILC156M module status	Off	If power is applied to the system, an internal fault with the ILC156M may exist.
		Green	Normal operation.
		Yellow	Minor alarm condition exists.
		Red	Major alarm condition exists.
EMS	IL Manager system status	Off	The module's configuration is controlled by the onboard configuration switches.
		Green	The module's configuration has been set by IL Manager EMS. When green, the configuration switches have no effect on the module's operation.
TX (front panel only)	XFP transmitter status	Green	Normal TX operation.
		Red (flashing)	No XFP is installed or a transmitter fault exists.

Table 4. ILC156M Front and Rear Panel Status LEDs (Continued)

LED	Indicates ...	State	Description
RATE A-F	Channel input rate	Off	SD-SDI or ASI input signal detected.
		Green	HD-SDI input signal detected.
		Yellow	3G-SDI input signal detected.
STATUS A-F	Channel input status	Off	Channel disabled.
		Green	Video detected on channel.
		Yellow	No video detected on channel.
		Red	Input signal rate is outside the frequency range (+/-100 PPM).
		Red (flashing)	3G-SDI detected when 3G is not enabled. See the “Configuring the Video Rate with SW1, SW2, and SW3” section on page 5 if needed.

Using the ILC156M Monitor Jack

You can monitor the video that the ILC156M receives by using the front panel monitor port and associated Channel Select push button switch.

1. Connect the monitor cable between the monitor and the 75 Ohm HD-BNC monitor jack located on the ILC156M front panel (see [Figure 8](#)).
2. Push the **CHANNEL SELECT** button switch to sequentially monitor each channel's receive and transmit signals. When you push the switch, the selected signal's front panel LED blinks for 5 seconds to show which channel is being monitored. To advance to the next signal, push the switch again while it is blinking.

Removing the XFP and ILC156 Module

You can safely remove either the XFP from the ILC156 from the host chassis while power is applied to the module.

Note: This procedure applies to the ILC156M and ILC156D modules.

This section contains the following topics:

- [Removing the XFP \(page 12\)](#)
- [Removing the ILC156 Module \(page 13\)](#)

Removing the XFP

To remove the XFP from the ILC156, perform the following steps:

1. Remove the fiber optic cables from the XFP.

2. Pull down on the XFP handle to dislodge it from the ILC156.
3. Using the XFP handle, pull the XFP out of the module.

Removing the ILC156 Module

To remove the ILC156 from the host chassis, perform the following steps:

1. Remove the fiber optic cables from the XFP.
2. Remove the coaxial cables from the BNC connectors.
3. Loosen the two mounting screws that secure the ILC156 to the host chassis.
4. Using the two mounting screws, pull the ILC156 out of the host chassis.

Caution

To avoid problems associated with overheating, do not leave a function module slot open when power is applied to the chassis. Every module slot must contain a module or blank tray to ensure proper ventilation when power is applied.

Understanding and Using the ILC156D

This section, which describes how the ILC156D works and how to configure, install, and cable the module, contains the following topics:

- [ILC156D Module Functional Description \(page 13\)](#)
- [Overview of the ILC156D Module \(page 15\)](#)
- [Configuring the ILC156D \(page 16\)](#)
- [Installing the ILC156D Module and XFP \(page 18\)](#)
- [Cabling the ILC156D Module \(page 18\)](#)
- [Monitoring the ILC156D Module Operation \(page 19\)](#)
- [Removing the XFP and ILC156D Module \(page 21\)](#)

ILC156D Module Functional Description

This section provides a functional description of the ILC156D, including [Figure 9](#), which is a functional block diagram of the module.

Figure 9. ILC156D Module Functional Block Diagram

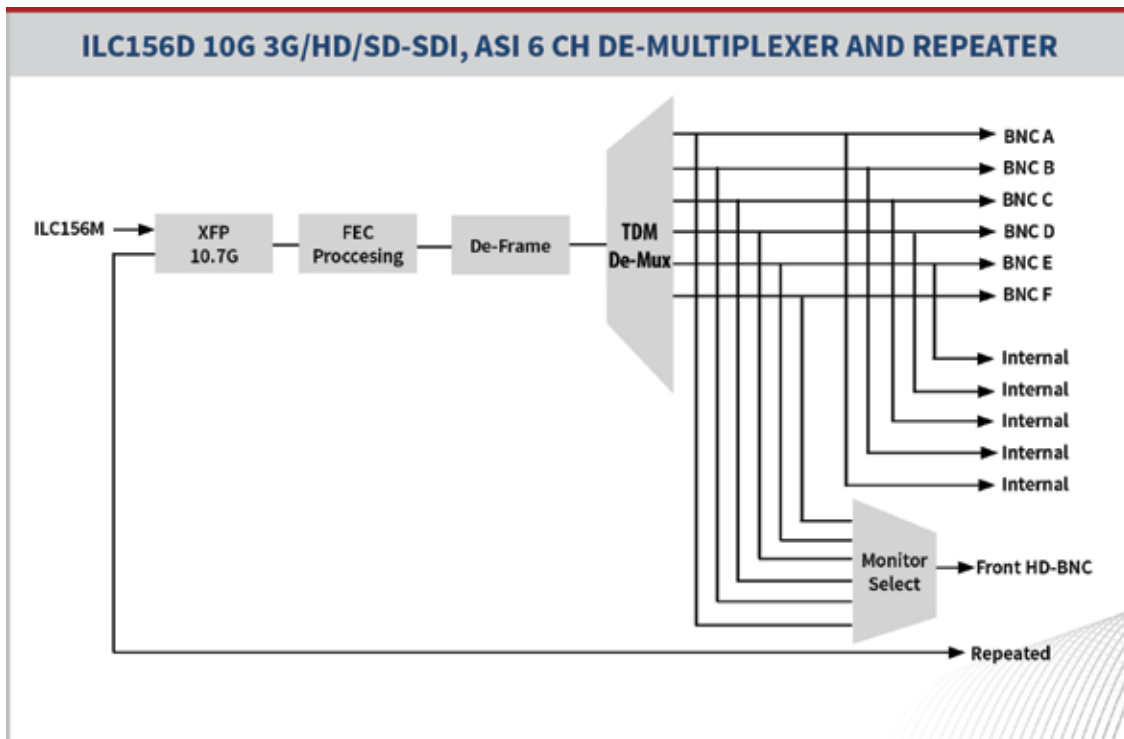

Electrical Outputs

The ILC156D uses the following electrical outputs:

- Six rear panel BNC connectors for channels A to F outputs.
- Backplane connector for transmitting outputs to other host chassis modules.
- Front-panel monitor jack, which is a 75 Ohm HD-BNC connector that allows you to monitor the output video signals on each channel.

Optical Inputs and Outputs

A single XFP socket provides the ILC156D optical interface that receives the aggregated video signal. When configured to operate as a repeater, the XFP transmits the reclocked aggregated video signal. The XFP modules use LC connectors. Optical performance is dependant on the quality of your optical fiber and fiber interconnects, and on the selected XFP module, which must be specifically qualified by Artel. Consult Artel for available XFP options.

Overview of the ILC156D Module

This section provides an overview of the components that make up the ILC156D.

Figure 10. ILC156D Module Major Components

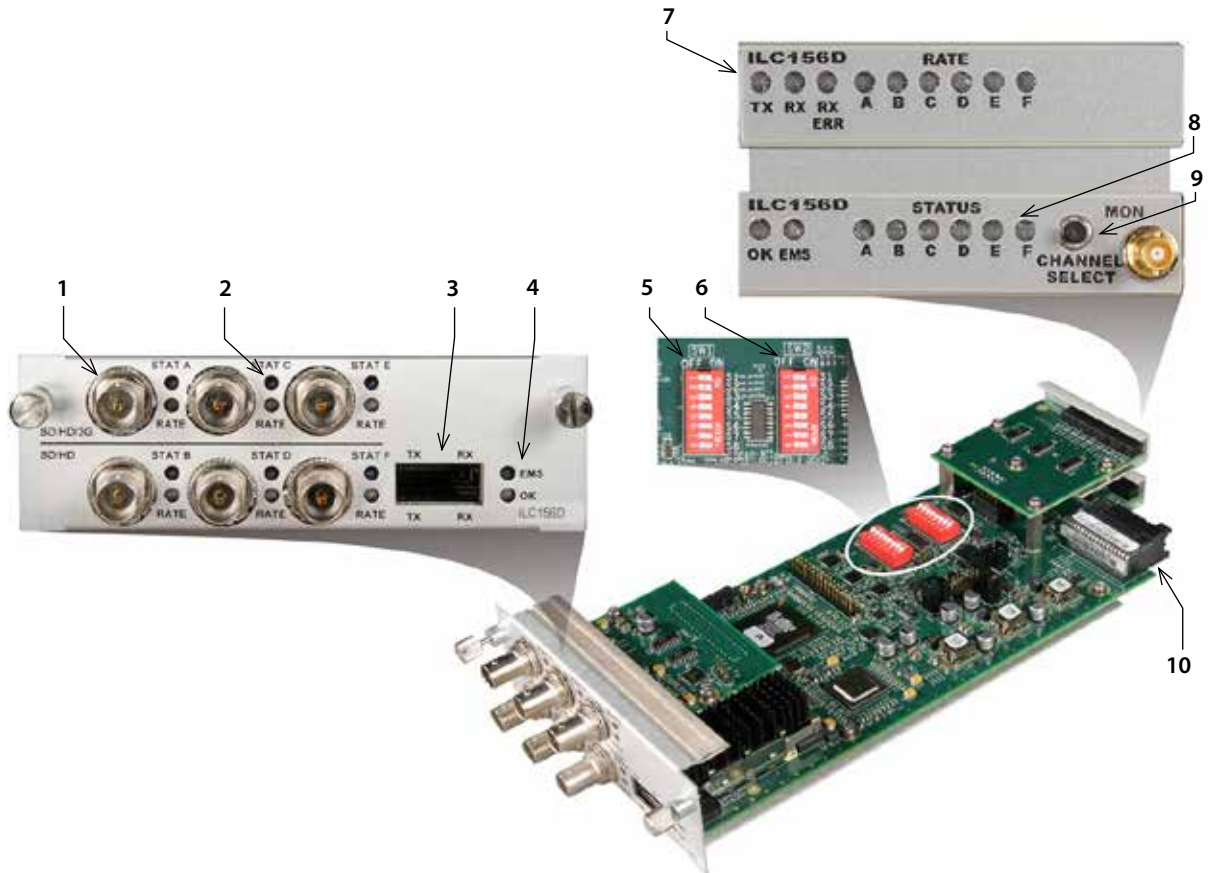

(Continued)

Table 5. ILC156D Elements

Item	ILC156D Element	for details, see...
1	BNC channel connectors for transmitting SD and HD video when used individually or SD, HD, and 3G when used as channel pairs as follows: <ul style="list-style-type: none"> • A—Paired with Channel B for 3G operation • B • C—Paired with Channel D for 3G operation • D • E—Paired with Channel F for 3G operation • F Note: 3G Operation can only be configured on the ILC156M.	Cabling the Video Output BNC Connections (page 19)
2	Rear panel BNC channel transmit status LEDs: <ul style="list-style-type: none"> • STAT—Output status indicator • RATE—Output rate indicator 	Understanding the ILC156D Status LEDs (page 19)
3	XFP socket for the following optical connections: <ul style="list-style-type: none"> • TX—Transmit • RX—Receive 	Cabling the XFP Connections (page 19)
4	Rear panel module status LEDs: <ul style="list-style-type: none"> • EMS—Element management system indicator • OK—Alarm indicator 	Understanding the ILC156D Status LEDs (page 19)
5	Channel enable DIP switch SW4.	Configuring the ILC156D (page 16)
6	Video alarm, optical repeater function, and EMS enable DIP switch SW5.	
7	Front panel status LEDs: <ul style="list-style-type: none"> • TX—XFP transmit status indicator • RX—XFP receive status indicator • RX ERR—Receive error indicator • RATE A–F—BNC receive rate indicator • OK—Alarm indicator • EMS—Element management system indicator • STATUS A–F—Channel status indicator 	Understanding the ILC156D Status LEDs (page 19)
8	Front panel Channel Select switch—Allows you to select the channel signal to monitor.	Using the ILC156D Monitor Jack (page 21)
9	Front panel monitor 75 Ohm HD-BNC output jack.	
10	Backplane connector—Provides power to the module, allows the module to share signals with other function modules, and is used for alarm and management signals.	N/A

Configuring the ILC156D

This section describes how to configure the operation of the ILC156D. You must configure the module while it is out of the chassis because the configuration DIP switches SW1 and SW2 are mounted to the top of the module printed circuit board.

Artel ships the ILC156D configured to operate as follows:

- All six channels enabled
- Optical transmit (TX) disabled
- Optical receive (RX) enabled
- Alarm for loss of video is disabled
- EMS override enabled (IL Manager can change the ILC156D configuration)

This section contains the following topics:

- [Enabling Channels with Switch SW1 \(page 17\)](#)
- [Enabling Video Alarm, Optical Repeater, and EMS with DIP Switch SW2 \(page 17\)](#)

Enabling Channels with Switch SW1

DIP Switch SW1 determines which video channels are enabled or disabled.

Figure 11. ILC156D DIP Switch SW1

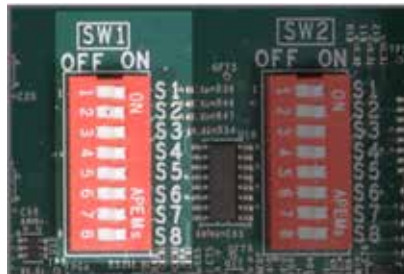

Table 7 describes the DIP switch SW1 configuration options. The factory-set configuration settings are shown in bold type.

Note: All reserved switches must be left in the ON position.

S1	A	Enabled	Disabled	S5	E	Enabled	Disabled
S2	B	Enabled	Disabled	S6	F	Enabled	Disabled
S3	C	Enabled	Disabled	S7	Reserved (leave ON)	X	–
S4	D	Enabled	Disabled	S8	Reserved (leave ON)	X	–

Enabling Video Alarm, Optical Repeater, and EMS with DIP Switch SW2

DIP Switch SW2 enables or disables the video alarm, optical repeater function, and EMS function.

Figure 12. All reserved switches must be left in the ON position.

ILC156D DIP Switch SW2

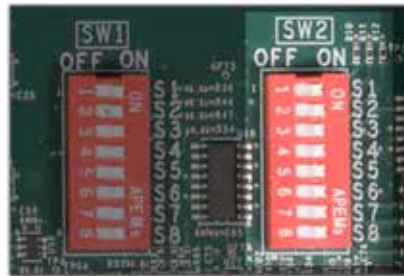

Table 8 describes the DIP switch SW2 configuration options. The factory-set configuration settings are shown in bold type.

Table 6. DIP Switch SW2 Settings

Switch	Function	ON	OFF
S1	Reserved (leave ON)	X	–
S2	Reserved (leave ON)	X	–
S3	Video alarm	No alarm.	Loss of video on an enabled input causes a major alarm.
S4	Repeater mode disabled	Repeater mode is disabled. TX laser is off.	Repeater mode is enabled. TX laser is on.
S5	Reserved (leave ON)	X	–
S6	Reserved (leave ON)	X	–
S7	Reserved (leave ON)	X	–
S8	EMS Enable	IL Manager can override the local switches.	IL Manager cannot override the local switches.

Installing the ILC156D Module and XFP

Installation of the ILC156D is the same as installing the ILC156M as described in the [“Installing the ILC156 Module and XFP”](#) section on page 8.

Cabling the ILC156D Module

The ILC156D receives optical video signals through an XFP and transmits electrical video signals over BNC cable connections (see [Figure 13](#)). The cabling configuration that you use depends on your application.

Figure 13. ILC156D BNC Connectors and XFP Socket



Cabling the Video Output BNC Connections

Use a high quality 75 Ohm precision video coax cable, such as Belden 1694A cable, when cabling to the ILC156D BNC connectors to the destination devices.

Cabling the XFP Connections

Use a single mode fiber when connecting to the LC connectors of the ILC156D XFP.

To cable the optical connections, perform the following tasks:

1. Remove the XFP safety plug that protects the RX and TX ports.
If you are not using the optical repeater function, cover the unused TX optical port to keep the port clean.
2. Connect the fiber optic cable between the XFP receive optical connector (RX) on the ILC156D and the source device.

If you are using the optical repeater function, connect the fiber optic cable between the XFP transmit optical connector (TX) on the ILC156D and the destination device. When repeating a signal from a ILC156M, the video BNC operate normally. The ILC156D can also repeat 10 Gigabit Ethernet. When used to repeat 10GigE, the BNCs are disabled.

Monitoring the ILC156D Module Operation

This section describes how to monitor the ILC156D operations using the front and rear panel LEDs and the front panel monitor connector.

This section contains the following topics:

- [Understanding the ILC156D Status LEDs \(page 19\)](#)
- [Using the ILC156D Monitor Jack \(page 21\)](#)

Understanding the ILC156D Status LEDs

[Table 9](#) describes the different states of the ILC156D status LEDs as shown in [Figure 14](#).

Figure 14. ILC156D Status LEDs and Monitor Connector



Table 7. ILC156D Front and Rear Panel Status LEDs

LED	Indicates ...	State	Description
OK	ILC156D module status	Off	If power is applied to the system, an internal fault with the ILC156D may exist.
		Green	Normal operation.
		Yellow	Minor alarm condition exists.
		Red	Major alarm condition exists.
EMS	IL Manager system status	Off	The module's configuration is controlled by the onboard configuration switches.
		Green	The module's configuration has been set by IL Manager EMS. When green, the configuration switches have no effect on the module's operation.
TX (front panel only)	XFP transmitter status	Off	Repeater is disabled; laser is off.
		Green	Normal repeater operation; TX is enabled.
		Green (flashing)	Locked to 10 Gig Ethernet and repeating – Video outputs disabled
		Red (flashing)	No XFP is installed or a transmitter fault exists.

Table 7. ILC156D Front and Rear Panel Status LEDs

LED	Indicates ...	State	Description
RX	XFP receiver status	Green	Normal operation.
		Yellow	High receiver power.
		Red	No XFP installed or an invalid input signal detected.
RX ERR	Receive errors	Off	No optical errors detected.
		Green (flashing)	Error detected and corrected.
		Yellow (flashing)	Error detected and corrected; high error rate warning.
		Red	Error detected that could not be corrected.
RATE A-F	Channel input rate	Off	SD-SDI or ASI input signal detected.
		Green	HD-SDI input signal detected.
		Yellow	3G-SDI input signal detected.
STATUS A-F	Channel input status	Off	Channel disabled.
		Green	Video detected on channel.
		Yellow	No video detected on channel.
		Red	Input signal rate is outside the frequency range (+/-100 PPM).
		Red (flashing)	3G-SDI signal blocked at source (ILC156M).

Using the ILC156D Monitor Jack

You can monitor the video that the ILC156D transmits out the BNC connectors by using the front panel monitor port and associated Channel Select push button switch.

To connect a monitor the ILC156D to view the transmit signals of a selected channel, perform the following steps:

1. Connect the monitor cable between the monitor and the 75 Ohm HD-BNC monitor jack located on the ILC156D front panel (see [Figure 14](#)).
2. Push the **CHANNEL SELECT** button switch to sequentially monitor each channel's receive signals. When you push the switch, the selected signal's front panel LED blinks for 5 seconds to show which channel is being monitored. To advance to the next signal, push the switch again while it is blinking.

Removing the XFP and ILC156D Module

Removing the ILC156M module or XFP is the same as removing the ILC156M as described in the ["Removing the XFP and ILC156 Module"](#) section on page 12.



Index

A

audience [ix](#)

B

backplane connector

ILC156D [16](#)

ILC156M [4](#)

block diagram

ILC156D [13](#)

ILC156M [2](#)

BNC connectors

ILC156D [15](#)

ILC156M [4](#)

C

cable interfaces

ILC156D [18](#)

ILC156M [10](#)

caution definition [x](#)

Channel Select switch

ILC156D [16](#)

ILC156M [4](#)

conventions [x](#)

Customer Service [x](#)

E

e-mail address, Customer Service [x](#)

F

functional description

ILC156D [13](#)

ILC156M [2](#)

L

LEDs

front panel

ILC156D [16](#)

ILC156M [4](#)

rear panel

ILC156D [16](#)

ILC156M [4](#)

M

module

cable

ILC156D [18](#)

ILC156M [10](#)

components

ILC156D [15](#)

ILC156M [3](#)

install

ILC156 [8](#)

remove

ILC156 [12](#)

monitor jack

ILC156D [21](#)

ILC156M [12](#)

monitor operations

ILC156D [19](#)

ILC156M [10](#)

monitor output jack

ILC156D [16](#)

ILC156M [4](#)

O

operations, monitor

ILC156D [19](#)

ILC156M [10](#)

R

related documentation [ix](#)

return authorization (RA) number [x](#)

S

shipment, damaged [x](#)

status LEDs

ILC156D [19](#)

ILC156M [10](#)

symbols [x](#)

W

warning definition [x](#)

X

XFP

cable

ILC156D [19](#)

ILC156M [10](#)

socket

ILC156D [16](#)

ILC156M [4](#)

Proven Products, Unrivaled Service, and Great Support



- Proven technology in a rugged, reliable package
- Supports all formats across all networks
- Intuitive and simplified user interfaces
- Integrated, modular, and flexible
- Compact and low power
- Off-the-shelf delivery
- Network requirements analysis and design services
- Training and installation support available
- 24x7x365 technical support available



Artel Video Systems Corp.
5B Lyberty Way, Westford, MA 01886 USA
T: 978-263-5775 | F: 978-263-9755 | www.artel.com
Domestic Sales: sales@artel.com
International Sales: internationalsales@artel.com
Technical Support: customer@artel.com

Content subject to change without notice.
©2017